

grata |||



Grata - Sunscreens

COLT
TOLLFAB

SHADING SYSTEMS

grata |||

Grata - Sunscreens

The **Grata** range of sunscreens and grilles are designed to be aesthetically pleasing, yet economical and highly functional. Whilst blocking out the sun's rays, **Grata** adds to a modern architectural facade and can assist in managing your building's environment, and energy requirements.

Grata panels can be mounted either horizontally or vertically to achieve the desired shading solution, or level of privacy required.

With a range of 5 blade profiles, 2 cross brace options and a variety of fixing methods, **Grata** allows you to select the combination that best suits your specific situation.

FEATURES INCLUDE:

- Range of blade and cross brace profiles
- A range of fixing options available to suit your specific installation needs
- Robust aluminium construction
- Can be framed or frameless
- Range of anodised or powdercoated finishes

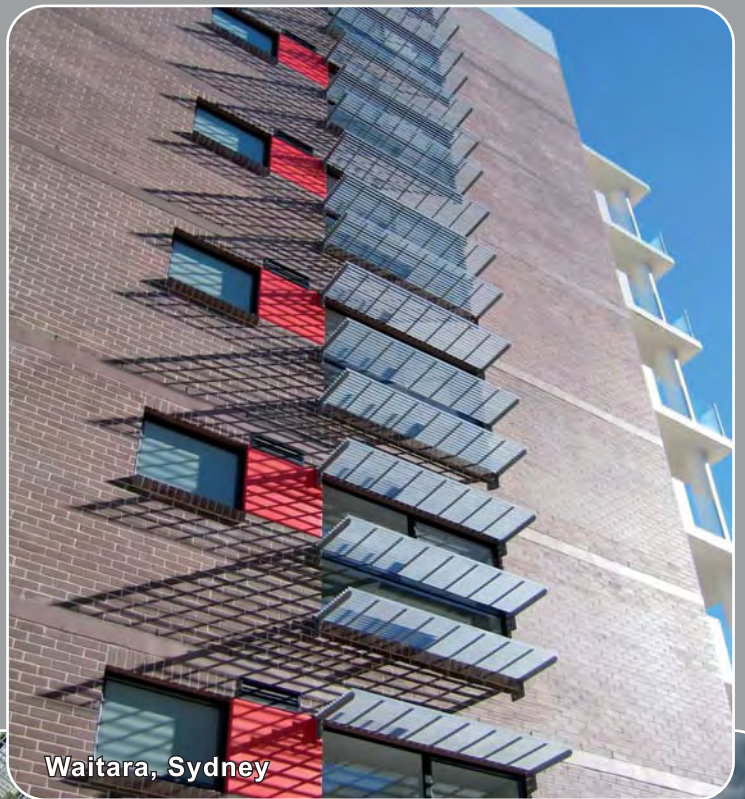

GRATA BLADE PROFILES

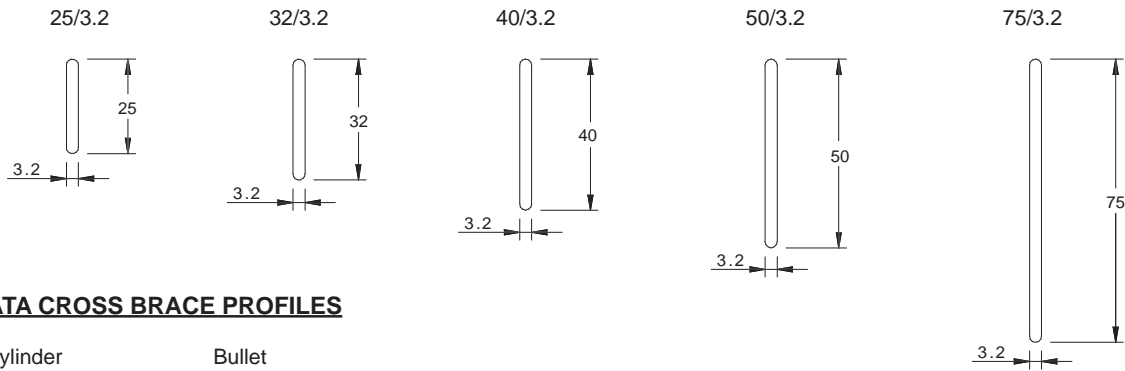

GRATA CROSS BRACE PROFILES

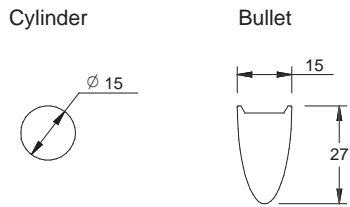

GRATA PANEL LAYOUT

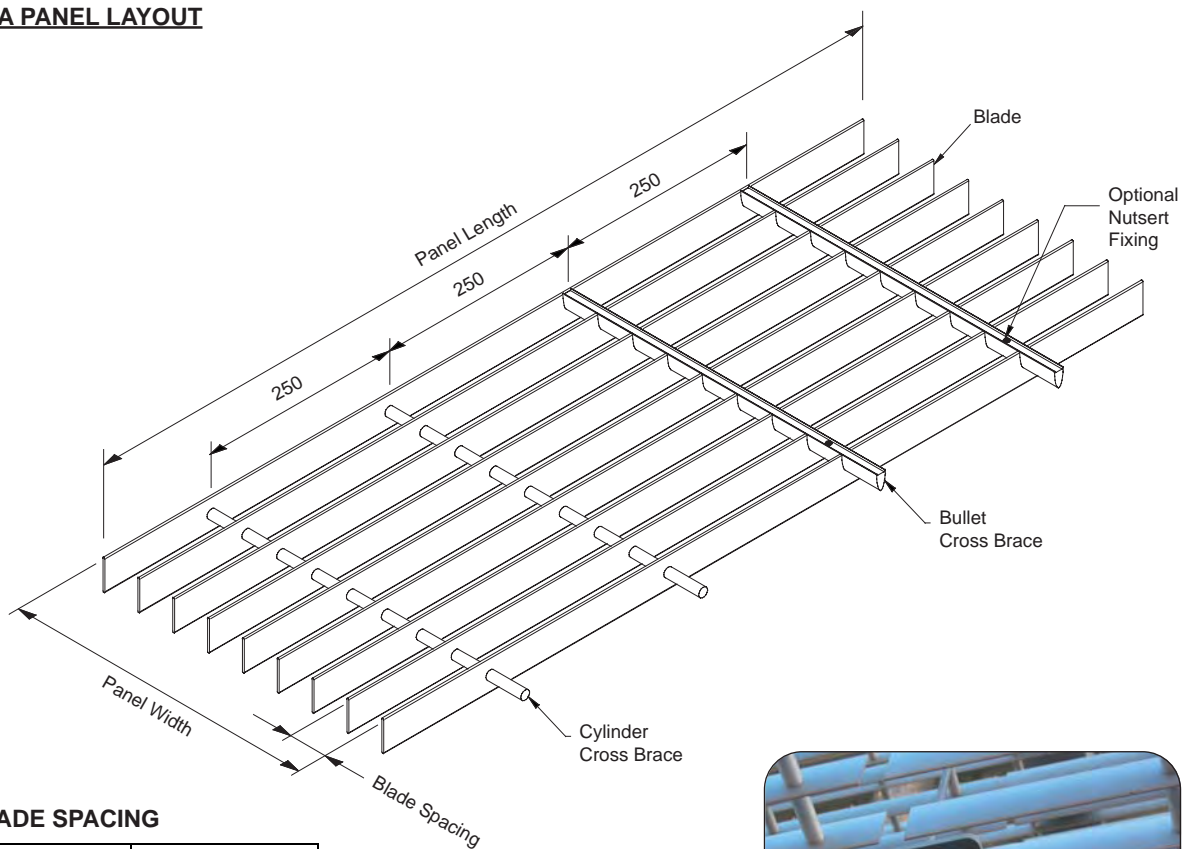

BLADE SPACING

Blade Type	Blade Spacing
25/3.2	30mm
32/3.2	40mm
40/3.2	40mm
50/3.2	60mm
75/3.2	60mm

Note: Grata Sunscreens can also be supplied in a trafficable form.



HOW TO SPECIFY

Available Product Options:

1. **Blade Type** - 22/3.2, 32/3.2, 40/3.2, 50/3.2 or 75/3.2
2. **Cross Brace Type** - Cylinder (C) or Bullet (B)
3. **Finish** - Anodised (A) "Colour" or Powdercoat (PC) "Colour"

Example of a Grata Specification:

Grata 40/3.2-C-PC "Colour"

By Colt Tollfab Pty Ltd
P: +61 2 8846 1000



grata |||

Grata - Sunscreens



Auburn, Sydney



TYPICAL GRATA FIXING OPTIONS

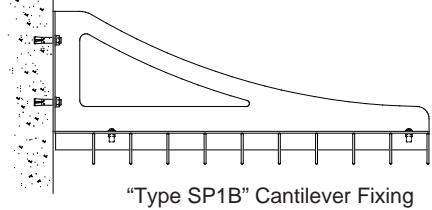
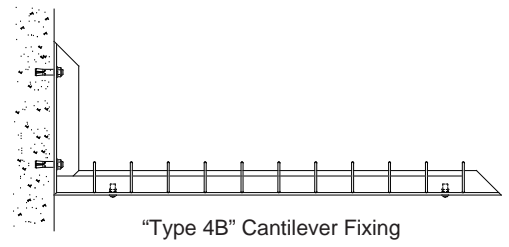
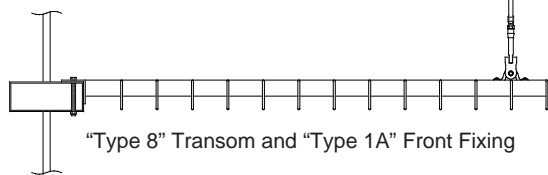
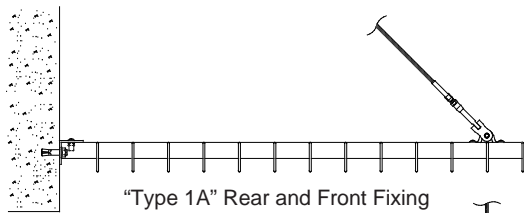

COLT
TOLLFAB

Colt Tollfab Pty Ltd ABN: 78 120 989 059

6-24 Antoine Street Rydalmere NSW 2116

P: +61 2 8846 1000 F: +61 2 8846 1088

www.colt-tollfab.com.au