

COLT



## EuroCO Roof Ventilator



Smoke & Climate Control

Front cover: Elderly peoples' home, Tegelen, the Netherlands.

## INTRODUCTION

EuroCO is a natural louvred ventilator that is available in a wide range of sizes, louvre options and control options. It is suited to most industrial and commercial buildings and can provide both day to day and smoke ventilation, as well as permit the entry of natural daylight if fitted with glass or polycarbonate blades.

EuroCO can also be installed in the vertical either for low level air inlet or for high level extract.

Louvred ventilators are popular with Specifiers and Contractors because of the wide range of options available, and with Building Operators and Owners because of their simplicity and low maintenance. They are among the most cost-effective kinds of natural ventilators.

## FEATURES & BENEFITS

**Wide range of applications** - EuroCO is classed as a dual purpose ventilator, providing both day to day and smoke control ventilation. Polycarbonate and glass versions allow the entry of natural daylight. EuroCO is also often used as a termination piece for large ducted or air handling systems. There are pneumatic, electronic or hand controls and a wide range of louvre types, accessories and finishes.

**High performance** - EuroCO is aerodynamically efficient and has a high resistance to weather.

**Proven performance** - EuroCO has been exhaustively tested and certified to EN 12101-2: 2003 in accredited third party test laboratories. For further details, see page 5.

**Easy to install** - EuroCO is delivered fully assembled to site and may be installed at any angle from 3° from the horizontal to the vertical. It has a wide range of base profiles to suit all sheeting, curb or glazing applications. A variable flanged variant is available for vertical installation into curtain walling, glazing or prepared openings.

**Weathered ventilation** - EuroCO can be installed onto a Colt Weatherlite ventilated upstand module for natural ventilation irrespective of weather conditions.

**Durable** - EuroCO is manufactured from tough, corrosion resistant aluminium, alloy, grade 3005 in accordance with EN573-3, with stainless steel fixings. Louvres pivot on double nylon UV-resistant bearings.

**Quality of manufacture** - EuroCO is manufactured under the BS EN 9001 quality standard. Each unit is given a functional test before despatch.

**Low maintenance** - EuroCO units have very low maintenance requirements.

**Design service** - Colt provides a pre-order design service. Please contact Colt for more information relating to the application, specification, installation or servicing of EuroCO.

- 1 Candy Podborany, Czech Republic.
- 2 Apartment Building, Hoorn, the Netherlands.
- 3 DHL, Hong Kong.
- 4 Gymnasium Dubnany, Czech Republic.
- 5 NS Station, Best, the Netherlands.
- 6 Ma On Shan Indoor Games Hall, Hong Kong.
- 7 Wulfren Centre, Wolverhampton.
- 8 Leprosy Relief Association, Singapore.



## OPTIONS

### Louvres

- Single skin aluminium (with option of low-loss brush seals to minimise air leakage or dust entry when closed)
- Insulated double skin aluminium (with option of low-loss brush seals)
- Twin wall opaque or clear polycarbonate, with rubber seals
- Single skin laminated or toughened glass, with rubber seals

### Flanges

For installation of EuroCO into a facade, whether this is into curtain walling, glazing or prepared openings, a front-flanged variant is available. The flange position is variable, depending on how far out from the building the ventilator is allowed to protrude.

For fixing details, see pages 12 and 13.

### Controls

- 24v dc or 230v ac OPV addressable electronic controls: failsafe open or close, or power to open and close. Option of a thermal release mechanism to open the vent at a pre-defined temperature (72, 93 or 141°C) irrespective of the incoming control signals. For more details, see page 10.
- Pneumatic controls: failsafe open or close, or double locking. Option of a thermal release mechanism to open the vent at a pre-defined temperature (68 or 93 °C). irrespective of the incoming control signals.
- Manual. Option of a thermal release mechanism to open the vent at a pre-defined temperature (72, 93 or 141°C) irrespective of the incoming control signals.

EuroCO may be linked to a Weatherbeater controller to ensure that it closes when it is raining.

### Guards

Birdguards, insect guards, security guards or burglar guards are available as factory fitted options.

### Other accessories

Optional accessories include fusible link shields, base extension plates, base covers and supports, sheeting closure pieces.

### Paint finishes

EuroCO is available mill finish, polyester powder coated to a RAL colour, or with a special finish such as PVF2.

Opposite: Sony, the Netherlands.

## TESTING

EuroCO has been successfully designed and tested by accredited third party test laboratories in accordance with EN 12101-2: 2003 according to the following parameters.



Hong Kong International Exhibition Centre.

Parameter	Objective	Result
Opening against side wind of 10 m/s	Ventilator will open in a strong wind	Pass
Aerodynamic tests	Ventilator will perform as efficiently as specified. Tested with the above mentioned side wind	See tables on pages 8-9
Reliability or lifecycle	Ventilator will be reliable	11,000 open and close cycles, rated as a dual purpose ventilator
Snow	Ventilator will open and remain open under load	Varies according to size. EuroCO meets SL 250 over the complete range.
Wind suction load	When closed the ventilator has to withstand the negative (suction) pressure of the class.	Varies according to louvre type. EuroCO meets WL 1500 (1.5 kPa) with louvre blades wider than 1.5m, and WL 3000 (3.0 kPa) with louvre blades under 1.5m wide.
Low internal temperature	Ventilator will be reliable at low temperature	EuroCO will operate at temperatures of down to -25°C.
Resistance to heat	In a fire situation the ventilator will open and stay open, and the area of the opening will not decrease by more than 10%.	EuroCO meets B 300 (300°C for 30 minutes).

## DIMENSIONS

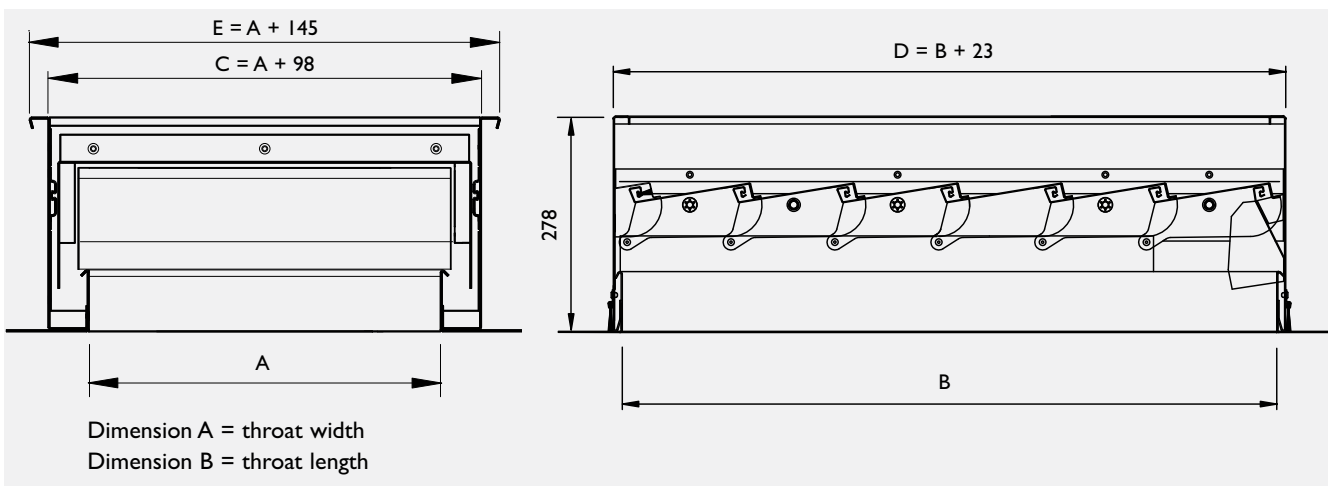

Dim	Width code						Length code													
	06	10	12	15	18	22	10	13	14	15	18	22	25	27	29	30	32	36	38	
A	426	876	1026	1326	1626	2000	B	705	971	1104	1237	1503	1902	2168	2434	2567	2700	2966	3365	3498
C	524	974	1124	1424	1724	2098	D	728	994	1127	1260	1526	1925	2191	2457	2590	2723	2989	3388	3521
E	571	1021	1171	1471	1771	2145														



## LOUVRE TYPES, U VALUES & AIR PERMEABILITY

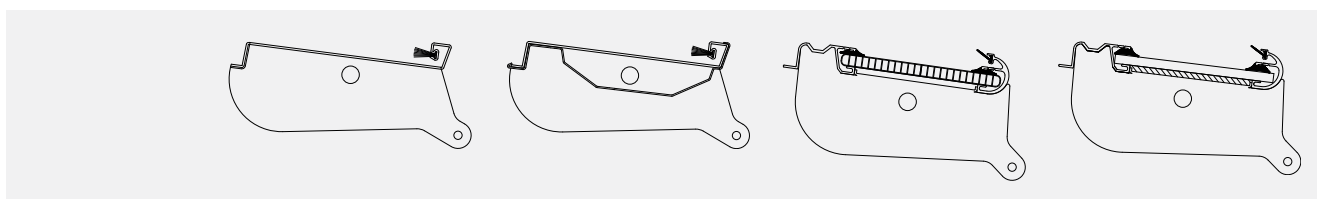

Louvre type	A1. Single skin aluminium (with option of low-loss brush seals)	A2. Insulated double skin aluminium (with option of low-loss brush seals)	PC/PO. Twin wall opaque or clear polycarbonate with rubber seals	GR. Single skin Georgian wired laminated or toughened glass, with rubber seals
Average louvre blade U value W/m <sup>2</sup> K	6.0	3.1	3.2	5.4
Average complete ventilator U value W/m <sup>2</sup> K	6.0	4.2	4.2	5.8

For a low-loss ventilator air permeability varies between 130 and 230m<sup>3</sup>/h/m<sup>2</sup> at 50 Pa, depending on ventilator size.



## WEIGHTS

The controls options and louvre type affect the weight of the ventilator.

The table gives weights with aluminium louvres.

Add 5kg for OPV electronic controls, 2.8kg for pneumatic controls and 1kg for manual controls.

Length code	Width code					
	06	10	12	15	18	22
10	15	21	23	26	30	38
13	18	24	27	31	36	45
14	19	26	29	33	38	49
15	21	28	31	36	41	53
18	23	32	35	40	46	60
22	27	37	41	47	54	71
25	30	41	45	52	59	79
27	33	45	49	57	64	85
29	34	47	51	59	67	90
30	35	48	53	61	70	93
32	38	52	57	66	74	100
36	42	58	63	73	83	111
38	44	61	65	76	85	115

## AERODYNAMIC PERFORMANCE

A = Measured throat area Av (m<sup>2</sup>)

Length code	Width code					
	06	10	12	15	18	22
10	0.30	0.62	0.72	0.93	1.15	1.41
13	0.41	0.85	1.00	1.29	1.58	1.94
14	0.47	0.97	1.13	1.46	1.80	2.21
15	0.53	1.08	1.27	1.64	2.01	2.47
18	0.64	1.32	1.54	1.99	2.44	3.01
22	0.81	1.67	1.95	2.52	3.09	3.80
25	0.92	1.90	2.22	2.87	3.53	4.34
27	1.04	2.13	2.50	3.23	3.96	4.87
29	1.09	2.25	2.63	3.40	4.17	5.13
30	1.15	2.37	2.77	3.58	4.39	5.40
32	1.26	2.60	3.04	3.93	4.82	5.93
36	1.43	2.95	3.45	4.46	5.47	6.73
38	1.49	3.06	3.59	4.64	5.69	7.00

**B = Coefficient Cv**

Length code	Width code					
	06	10	12	15	18	22
10	0.70	0.65	0.65	0.65	0.65	0.65
13	0.70	0.65	0.65	0.65	0.65	0.65
14	0.70	0.65	0.65	0.65	0.65	0.65
15	0.70	0.65	0.65	0.65	0.65	0.65
18	0.70	0.65	0.65	0.65	0.65	0.65
22	0.70	0.65	0.65	0.65	0.65	0.65
25	0.70	0.65	0.65	0.65	0.65	0.65
27	0.70	0.65	0.65	0.65	0.65	0.65
29	0.70	0.65	0.65	0.65	0.65	0.65
30	0.70	0.65	0.65	0.65	0.65	0.65
32	0.70	0.65	0.65	0.65	0.65	0.65
36	0.70	0.65	0.65	0.65	0.65	0.65
38	0.70	0.65	0.65	0.65	0.65	0.65

**AERODYNAMIC PERFORMANCE**  
continued**C = Aerodynamic free area AvCv (m<sup>2</sup>)**

Length code	Width code					
	06	10	12	15	18	22
10	0.21	0.40	0.47	0.61	0.75	0.92
13	0.29	0.55	0.65	0.84	1.03	1.26
14	0.33	0.63	0.73	0.95	1.17	1.44
15	0.37	0.70	0.82	1.07	1.31	1.61
18	0.45	0.86	1.00	1.30	1.59	1.95
22	0.57	1.08	1.27	1.64	2.01	2.47
25	0.65	1.23	1.45	1.87	2.29	2.82
27	0.73	1.39	1.62	2.10	2.57	3.16
29	0.77	1.46	1.71	2.21	2.71	3.34
30	0.81	1.54	1.80	2.33	2.85	3.51
32	0.88	1.69	1.98	2.56	3.13	3.86
36	1.00	1.92	2.24	2.90	3.56	4.37
38	1.04	1.99	2.33	3.01	3.70	4.55

## EN OPV CONTROLS

Colt recommends use of 24v dc or 230v ac OPV electronic controls. EN OPV revolutionises the control and operation of smoke control systems, enabling all addressable equipment to be integrated within a complete intelligent electronic control system, enabling any alterations to the scheme to be accommodated by simple changes in the software, and allowing monitoring and fault-diagnostics.

The user can operate the system manually at the control panel keypad and can amend the daily parameters such as the temperature settings and operating times.

The EN OPV system includes a battery backup unit offering two independent power sources to operate a ventilator, in accordance with the latest EN standards. This unit ensures that if there is a power failure the ventilator will remain shut for a pre-programmed duration, thereby reducing the prospect of water ingress, unless there is a fire signal, whereupon the ventilator will revert to its failsafe position (normally open). After that time has elapsed, the ventilator will default to the open position.

As an additional precaution, once the air adjacent to the ventilator reaches a pre-set

temperature (generally either 72, 94 or 141°C), if no fire override signal has received, the ventilator will failsafe to its open position.

Please see the EN OPV leaflet for more details.

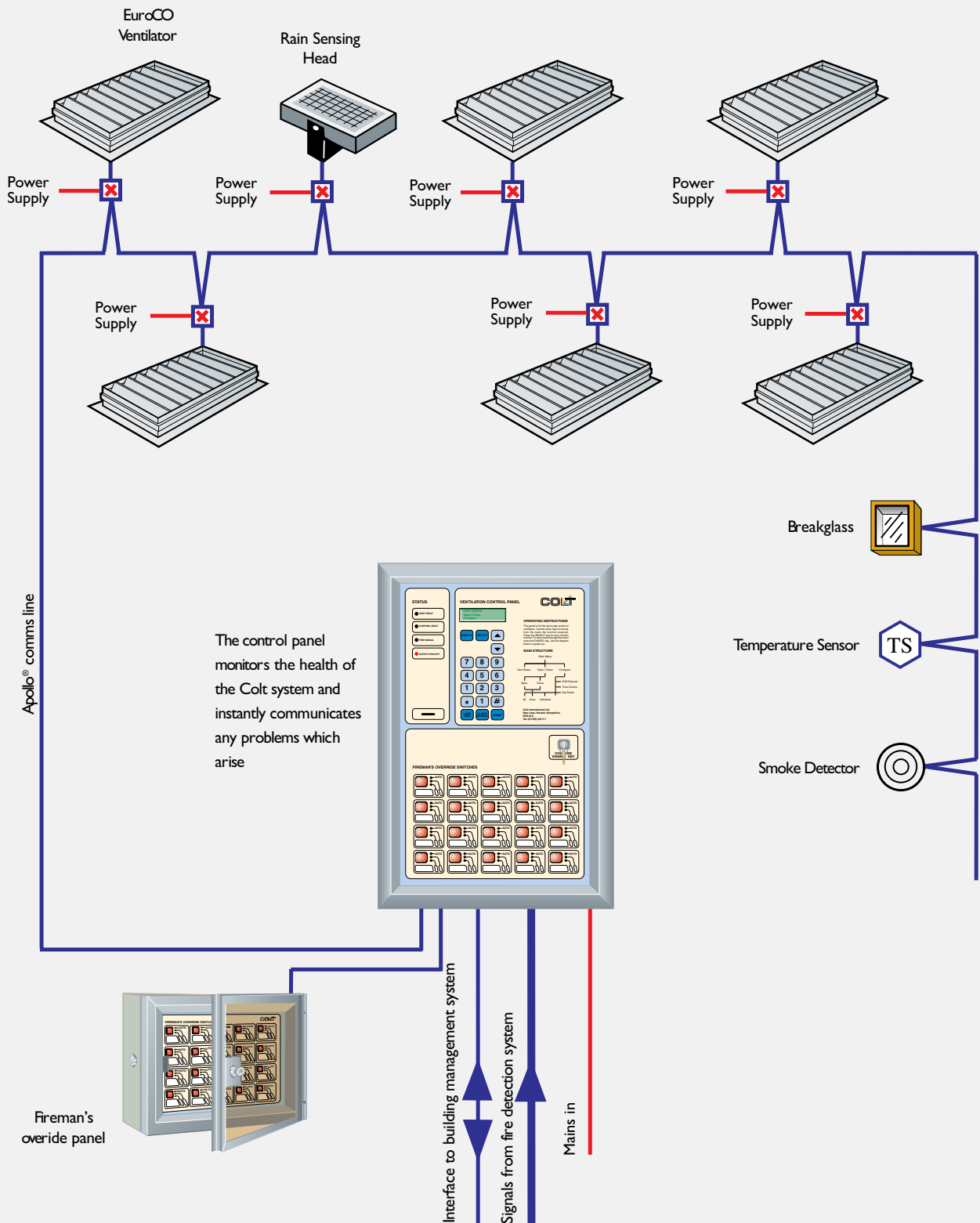

FIXING DETAILS

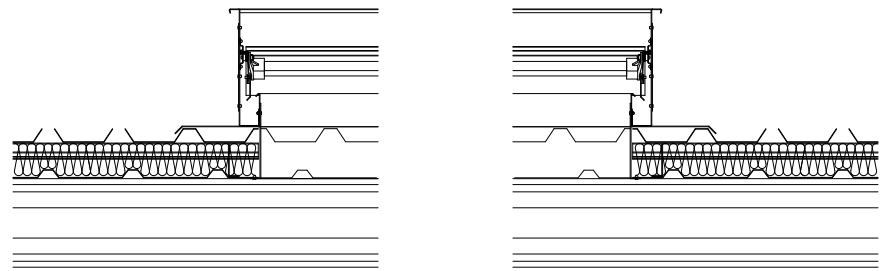

TYPICAL BASE DETAILS FOR SHEETING

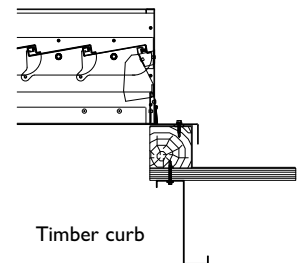
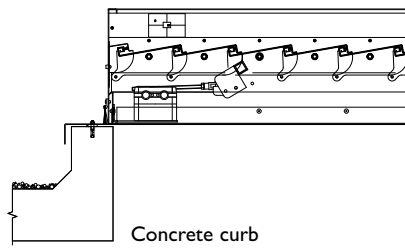
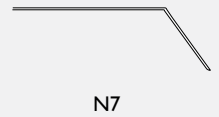
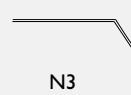
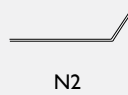

TYPICAL BASE DETAIL FOR CURBS

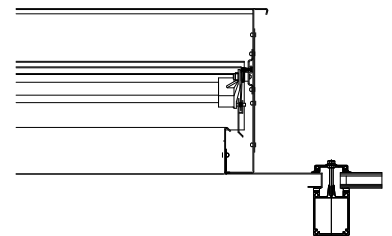
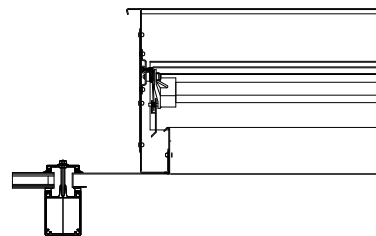
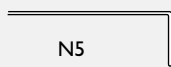

TYPICAL BASE DETAILS FOR GLAZING

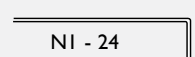
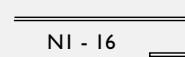
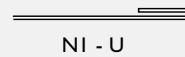

- 1 Ma On Shan Indoor Games Hall, Hong Kong.
- 2 Dongguan Exhibition Centre, China.
- 3 Linde, Czech Republic.
- 4 Microsoft, Reading.
- 5 Siemens Factory, China.

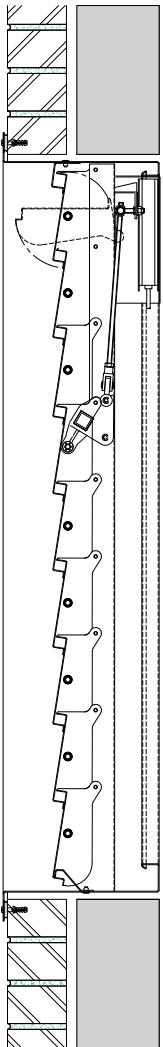

TYPICAL FIXING DETAIL  
 INTO BRICKWORK  
 (front flanged version shown)





Above: Hong Kong International Exhibition Centre.

## SPECIFICATION

### Product Reference

Colt EuroCO

### Description

Clear opening natural louvred ventilator. Dual purpose, for highly efficient natural ventilation and smoke control, and suited either for extraction or inlet. Tested to, and in compliance with EN 12101-2.

### Material

All principal components manufactured from corrosion resistant aluminium alloy grade 3005 in accordance with EN573-3, with stainless steel fixings.

### Sizes

Six width options to suit 426mm throat width (06), to 2000mm throat width (22). Thirteen length options available from 705mm (10), to 3498mm (38) throat length.

### Louvre blades

Single skin aluminium/ Insulated double skin aluminium / Twin wall opaque or clear polycarbonate / Single skin Georgian wired, laminated or toughened glass. Fitted with low-loss seals to minimise air leakage or dust entry when closed.

### Base fixing type

Aluminium base profile to suit sheeting/ curb/ glazing curtain walling systems.

### Controls

24v dc or 230v ac OPV addressable electronic: failsafe open or close, or power to open and close/ Pneumatic: failsafe open or close, or double locking /Manual

For each alternative, option for thermal release at the ventilator for added security.

### Guards

Factory fitted Bird guard / Insect guard / Security guard / Burglar guard

### Other accessories

Fusible link shield/ Base extension plates/ Base covers and supports/ Sheeting closure pieces

### Finish

Mill finish Aluminium/ Polyester Powder Paint Finish.

- 1 CCM Prague, Czech Republic.
- 2 Linde Frigera, Czech Republic.
- 3 Leprosy Relief Association, Singapore.
- 4 Ratiopharm, Vienna.
- 5 Dongguan Exhibition Centre, China.
- 6 Asia World Expo Station, Hong Kong.
- 7 DHL, Hong Kong.



## THE COLT PACKAGE

### Colt International offers the following services:

- Scheme design of all types of Smoke and Heat Exhaust Ventilation Systems (SHEVS)
- Scheme design of pressurisation systems
- Scheme design of smoke containment systems
- Provision of performance specifications
- Project management
- Supply, installation, commissioning and maintenance of systems, including all necessary controls, which will be designed to interface with others' control systems.

### Other reasons to choose Colt:

- Colt Smoke Control systems are suited to both commercial and industrial buildings, and may be adapted to suit most architectural requirements.
- Over the years Colt has funded a large proportion of the research into smoke control, and its representatives maintain an unparalleled level of technical expertise.
- Colt's in-house research and development capability ensures that Colt smoke control systems are designed, tested and updated by Colt to meet or exceed relevant legislation and standards.
- The majority of Colt's Smoke Control systems are manufactured in the UK under EN ISO 9001:2000 and EN ISO 14001:2004.

## SERVICE AND MAINTENANCE

Maintenance of a smoke control system is essential. Regular maintenance protects your investment and brings peace of mind that the system will operate effectively in an emergency.

The British Standard BS 5588-12 recommends that smoke control systems should be serviced at least once a year and tested weekly.

Colt offers a comprehensive range of maintenance packages incorporating the maintenance and repair of all building services equipment including non Colt products.



**Gauteng - Head Office**  
Tel: (011) 608-4640  
Fax: (011) 608-4643

**Kwa Zulu Natal**  
Tel: (031) 563-3749  
Fax: (031) 563-5319

**Western Cape**  
Tel: (021) 385-1967  
Fax: (021) 385-1567

info@robventind.co.za • www.robventind.co.za

